

COMBINATORIAL SEARCH

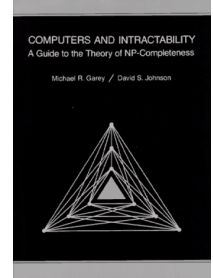

- ▶ permutations
- ▶ backtracking
- ▶ counting
- ▶ subsets
- ▶ paths in a graph

Implications of NP-completeness



“I can’t find an efficient algorithm, but neither can all these famous people.”

Overview

Exhaustive search. Iterate through all elements of a search space.

Applicability. Huge range of problems (include intractable ones).



Caveat. Search space is typically exponential in size \Rightarrow effectiveness may be limited to relatively small instances.

Backtracking. Systematic method for examining **feasible** solutions to a problem, by systematically pruning infeasible ones.

Warmup: enumerate N-bit strings

Goal. Process all 2^N bit strings of length N .

- Maintain array $a[]$ where $a[i]$ represents bit i .
- Simple recursive method does the job.

```
// enumerate bits in a[k] to a[N-1]
private void enumerate(int k)
{
    if (k == N)
    { process(); return; }
    enumerate(k+1);
    a[k] = 1;
    enumerate(k+1);
    a[k] = 0; ← clean up
}
```

$N = 3$

0	0	0
0	0	1
0	1	0
0	1	1
0	1	0
0	0	0
1	0	0
1	0	1
1	0	0
1	1	0
1	1	1
1	1	0
1	0	0
0	0	0

$N = 4$

0	0	0	0
0	0	0	1
0	0	1	0
0	0	1	1
0	1	0	0
0	1	0	1
0	1	1	0
0	1	1	1
1	0	0	0
1	0	0	1
1	0	1	0
1	0	1	1
1	1	0	0
1	1	0	1
1	1	1	0
1	1	1	1

$a[0]$ $a[N-1]$

Remark. Equivalent to counting in binary from 0 to $2^N - 1$.

Warmup: enumerate N-bit strings

```
public class BinaryCounter
{
    private int N;    // number of bits
    private int[] a; // a[i] = ith bit
```

```
    public BinaryCounter(int N)
    {
        this.N = N;
        this.a = new int[N];
        enumerate(0);
    }
```

```
    private void process()
    {
        for (int i = 0; i < N; i++)
            StdOut.print(a[i] + " ");
        StdOut.println();
    }
```

```
    private void enumerate(int k)
    {
        if (k == N)
            { process(); return; }
        enumerate(k+1);
        a[k] = 1;
        enumerate(k+1);
        a[k] = 0;
    }
}
```

```
public static void main(String[] args)
{
    int N = Integer.parseInt(args[0]);
    new BinaryCounter(N);
}
```

```
% java BinaryCounter 4
0 0 0 0
0 0 0 1
0 0 1 0
0 0 1 1
0 1 0 0
0 1 0 1
0 1 1 0
0 1 1 1
1 0 0 0
1 0 0 1
1 0 1 0
1 0 1 1
1 1 0 0
1 1 0 1
1 1 1 0
1 1 1 1
```

all programs in this
lecture are variations
on this theme



- ▶ **permutations**
- ▶ backtracking
- ▶ counting
- ▶ subsets
- ▶ paths in a graph

N-rooks problem

Q. How many ways are there to place N rooks on an N -by- N board so that no rook can attack any other?

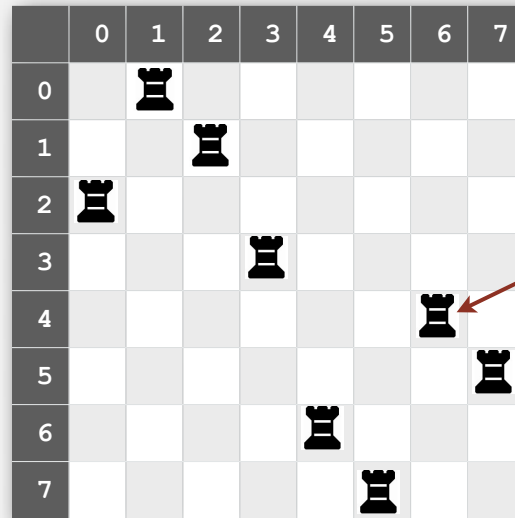

$a[4] = 6$ means the rook from row 4 is in column 6

```
int[] a = { 2, 0, 1, 3, 6, 7, 4, 5 };
```

Representation. No two rooks in the same row or column \Rightarrow permutation.

Challenge. Enumerate all $N!$ permutations of N integers 0 to $N - 1$.

Enumerating permutations

Recursive algorithm to enumerate all $N!$ permutations of N elements.

- Start with permutation $a[0]$ to $a[N-1]$.
- For each value of i :
 - swap $a[i]$ into position 0
 - enumerate all $(N-1)!$ permutations of $a[1]$ to $a[N-1]$
 - clean up (swap $a[i]$ back to original position)

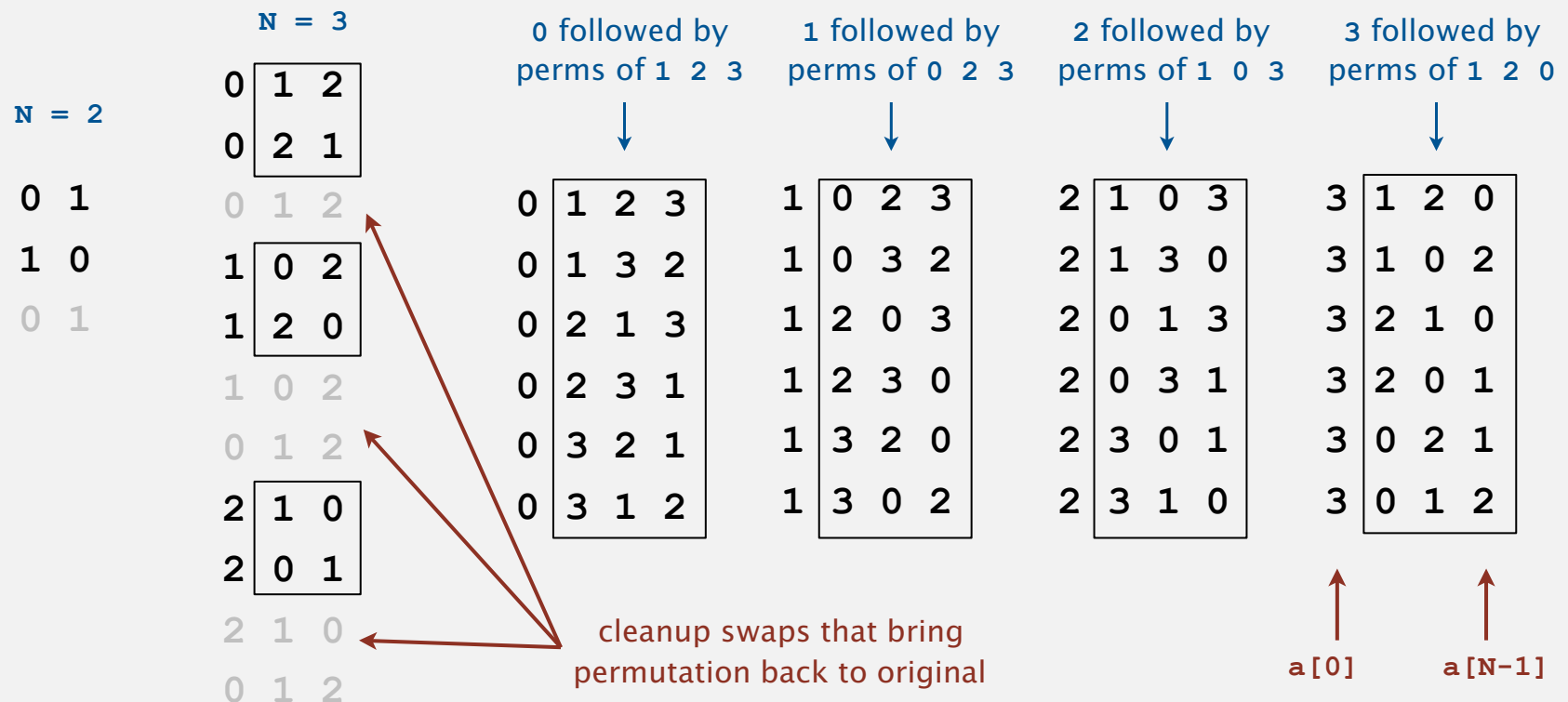

Enumerating permutations

Recursive algorithm to enumerate all $N!$ permutations of N elements.

- Start with permutation $a[0]$ to $a[N-1]$.
- For each value of i :
 - swap $a[i]$ into position 0
 - enumerate all $(N-1)!$ permutations of $a[1]$ to $a[N-1]$
 - clean up (swap $a[i]$ back to original position)

```
// place N-k rooks in a[k] to a[N-1]
private void enumerate(int k)
{
    if (k == N)
    { process(); return; }

    for (int i = k; i < N; i++)
    {
        exch(k, i);
        enumerate(k+1);
        exch(i, k); ← clean up
    }
}
```

```
% java Rooks 4
0 1 2 3
0 1 3 2
0 2 1 3 0 followed by
0 2 3 1 perms of 1 2 3
0 3 2 1
0 3 1 2
1 0 2 3
1 0 3 2
1 2 0 3 1 followed by
1 2 3 0 perms of 0 2 3
1 3 2 0
1 3 0 2
2 1 0 3
2 1 3 0
2 0 1 3 2 followed by
2 0 3 1 perms of 1 0 3
2 3 0 1
2 3 1 0
3 1 2 0
3 1 0 2
3 2 1 0 3 followed by
3 2 0 1 perms of 1 2 0
3 0 2 1
3 0 1 2
```

$a[0]$ $a[N-1]$

Enumerating permutations

```
public class Rooks
{
    private int N;
    private int[] a; // bits (0 or 1)

    public Rooks(int N)
    {
        this.N = N;
        a = new int[N];
        for (int i = 0; i < N; i++)
            a[i] = i;           ← initial permutation
        enumerate(0);
    }

    private void enumerate(int k)
    { /* see previous slide */ }

    private void exch(int i, int j)
    { int t = a[i]; a[i] = a[j]; a[j] = t; }

    public static void main(String[] args)
    {
        int N = Integer.parseInt(args[0]);
        new Rooks(N);
    }
}
```

```
% java Rooks 2
0 1
1 0

% java Rooks 3
0 1 2
0 2 1
1 0 2
1 2 0
2 1 0
2 0 1
```

4-rooks search tree

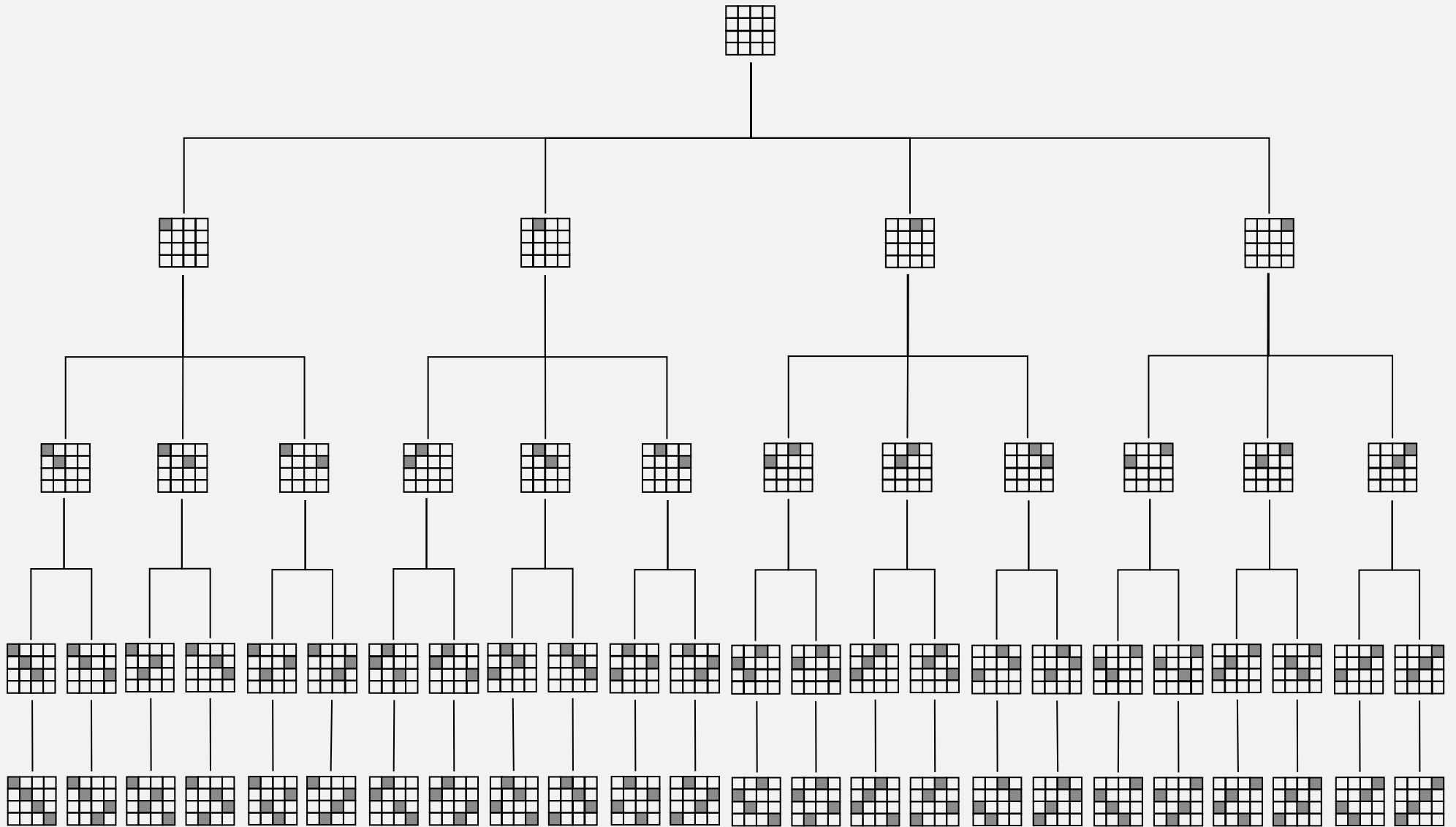

... solutions

N-rooks problem: back-of-envelope running time estimate

Slow way to compute $N!$.

<pre>% java Rooks 7 wc -l 5040</pre>	← instant
<pre>% java Rooks 8 wc -l 40320</pre>	← 1.6 seconds
<pre>% java Rooks 9 wc -l 362880</pre>	← 15 seconds
<pre>% java Rooks 10 wc -l 3628800</pre>	← 170 seconds
<pre>% java Rooks 25 wc -l ...</pre>	← forever

Hypothesis. Running time is about $2(N! / 8!)$ seconds.

- ▶ permutations
- ▶ **backtracking**
- ▶ counting
- ▶ subsets
- ▶ paths in a graph

N-queens problem

Q. How many ways are there to place N queens on an N -by- N board so that no queen can attack any other?

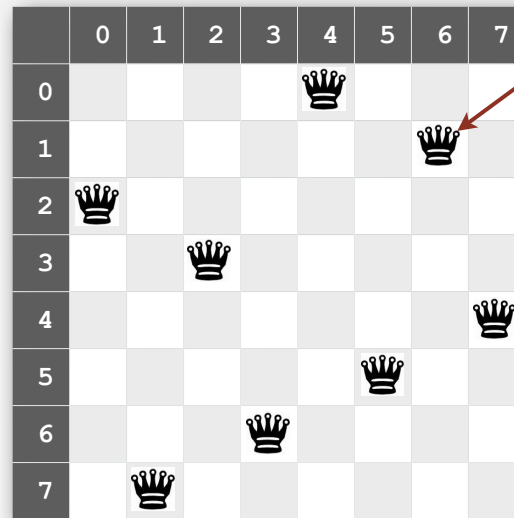

$a[1] = 6$ means the queen from row 1 is in column 6

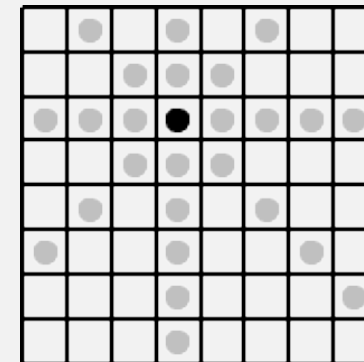

```
int[] a = { 2, 7, 3, 6, 0, 5, 1, 4 };
```

Representation. No two queens in the same row or column \Rightarrow permutation.

Additional constraint. No diagonal attack is possible.

Challenge. Enumerate (or even count) the solutions. \leftarrow

unlike N-rooks problem,
nobody knows answer for $N > 30$

4-queens search tree

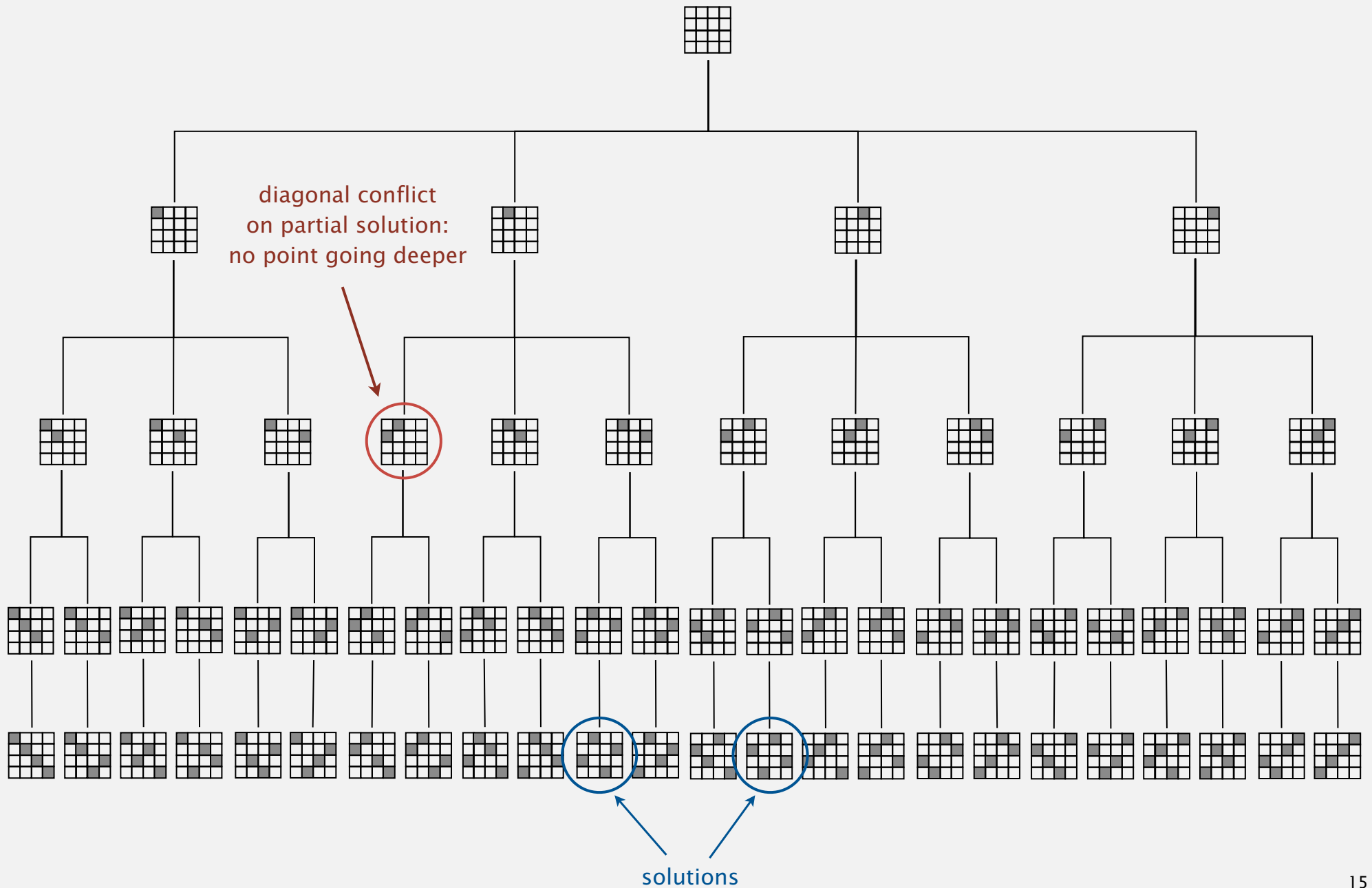

4-queens search tree (pruned)

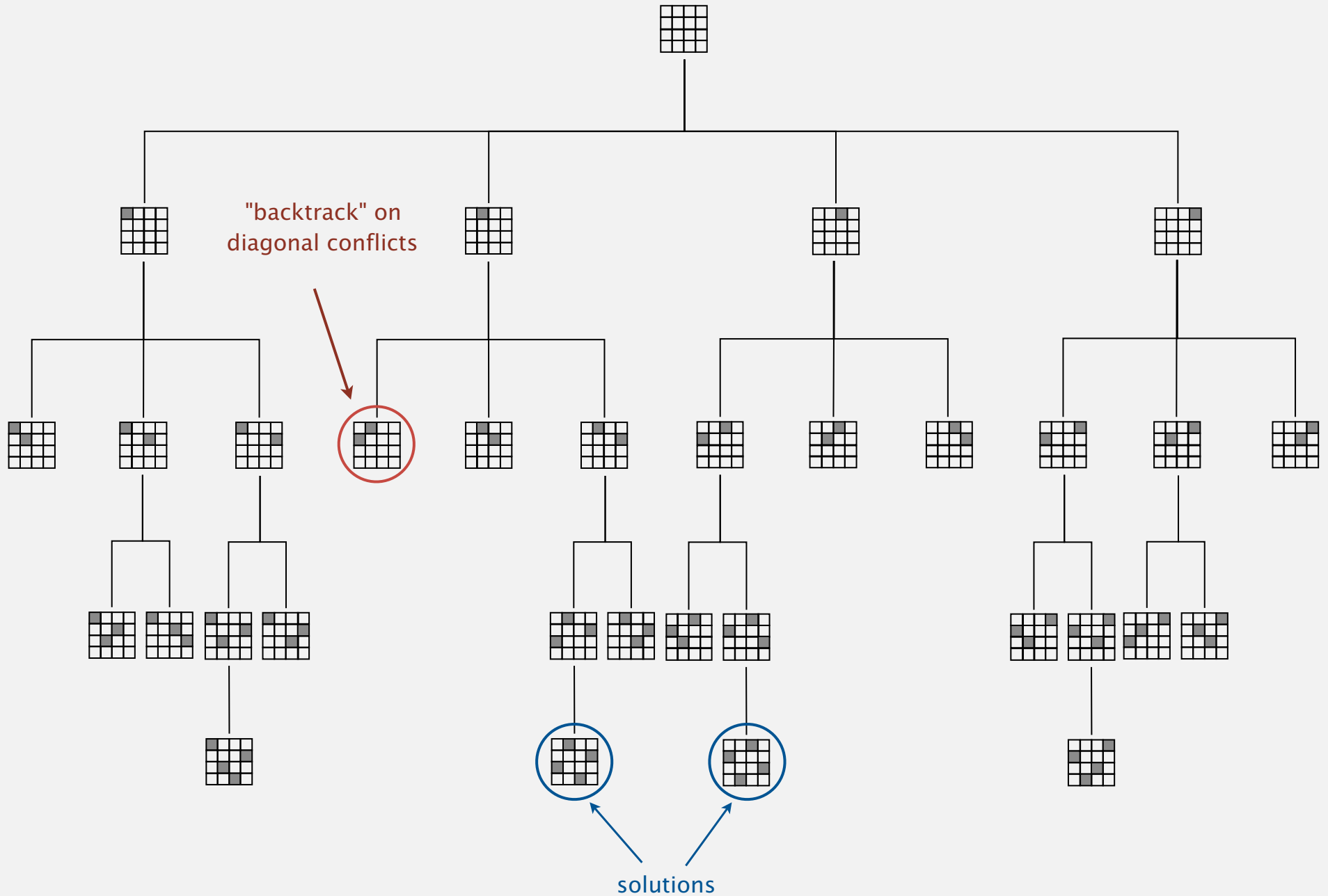

N-queens problem: backtracking solution

Backtracking paradigm. Iterate through elements of search space.

- When there are several possible choices, make one choice and recur.
- If the choice is a **dead end**, backtrack to previous choice, and make next available choice.

Benefit. Identifying dead ends allows us to **prune** the search tree.

Ex. [backtracking for N -queens problem]

- Dead end: a diagonal conflict.
- Pruning: backtrack and try next column when diagonal conflict found.

N-queens problem: backtracking solution

```
private boolean canBacktrack(int k)
{
    for (int i = 0; i < k; i++)
    {
        if ((a[i] - a[k]) == (k - i)) return true;
        if ((a[k] - a[i]) == (k - i)) return true;
    }
    return false;
}
```

```
// place N-k queens in a[k] to a[N-1]
```

```
private void enumerate(int k)
{
    if (k == N)
    { process(); return; }

    for (int i = k; i < N; i++)
    {
        exch(k, i);
        if (!canBacktrack(k)) enumerate(k+1);
        exch(i, k);
    }
}
```

stop enumerating if
adding queen k leads
to a diagonal violation

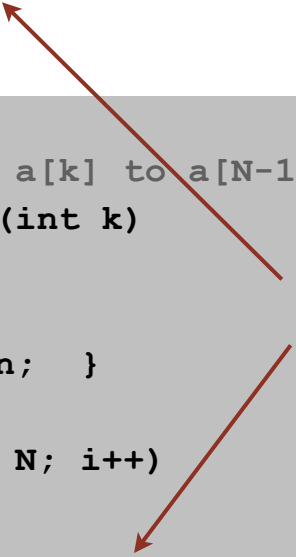

```
% java Queens 4
1 3 0 2
2 0 3 1
```

```
% java Queens 5
0 2 4 1 3
0 3 1 4 2
1 3 0 2 4
1 4 2 0 3
2 0 3 1 4
2 4 1 3 0
3 1 4 2 0
3 0 2 4 1
4 1 3 0 2
4 2 0 3 1
```

```
% java Queens 6
1 3 5 0 2 4
2 5 1 4 0 3
3 0 4 1 5 2
4 2 0 5 3 1
```

a[0]

a[N-1]

N-queens problem: effectiveness of backtracking

Pruning the search tree leads to enormous time savings.

N	Q(N)	N!
2	0	2
3	0	6
4	2	24
5	10	120
6	4	720
7	40	5,040
8	92	40,320
9	352	362,880
10	724	3,628,800
11	2,680	39,916,800
12	14,200	479,001,600
13	73,712	6,227,020,800
14	365,596	87,178,291,200

N-queens problem: How many solutions?

```
% java Queens 13 | wc -l  
73712
```

← 1.1 seconds

```
% java Queens 14 | wc -l  
365596
```

← 5.4 seconds

```
% java Queens 15 | wc -l  
2279184
```

← 29 seconds

```
% java Queens 16 | wc -l  
14772512
```

← 210 seconds

```
% java Queens 17 | wc -l  
...
```

← 1352 seconds

Hypothesis. Running time is about $(N! / 2.5^N) / 43,000$ seconds.

Conjecture. $Q(N) \sim N! / c^N$, where c is about 2.54.

- ▶ permutations
- ▶ backtracking
- ▶ **counting**
- ▶ subsets
- ▶ paths in a graph

Counting: Java implementation

Goal. Enumerate all N -digit base- R numbers.

Solution. Generalize binary counter in lecture warmup.

```
// enumerate base-R numbers in a[k] to a[N-1]
private static void enumerate(int k)
{
    if (k == N)
        { process(); return; }

    for (int r = 0; r < R; r++)
    {
        a[k] = r;
        enumerate(k+1);
    }
    a[k] = 0;
}
```

 cleanup not needed; why?

```
% java Counter 2 4
0 0
0 1
0 2
0 3
1 0
1 1
1 2
1 3
2 0
2 1
2 2
2 3
3 0
3 1
3 2
3 3
```

```
% java Counter 3 2
0 0 0
0 0 1
0 1 0
0 1 1
1 0 0
1 0 1
1 1 0
1 1 1
```

a[0] a[N-1]

Counting application: Sudoku

Goal. Fill 9-by-9 grid so that every row, column, and box contains each of the digits 1 through 9.

7		8				3		
			2		1			
5								
	4						2	6
3				8				
			1				9	
	9		6					4
				7		5		

Counting application: Sudoku

Goal. Fill 9-by-9 grid so that every row, column, and box contains each of the digits 1 through 9.

7	2	8	9	4	6	3	1	5
9	3	4	2	5	1	6	7	8
5	1	6	7	3	8	2	4	9
1	4	7	5	9	3	8	2	6
3	6	9	4	8	2	1	5	7
8	5	2	1	6	7	4	9	3
2	9	3	6	1	5	7	8	4
4	8	1	3	7	9	5	6	2
6	7	5	8	2	4	9	3	1

Solution. Enumerate all 81-digit base-9 numbers (with backtracking).

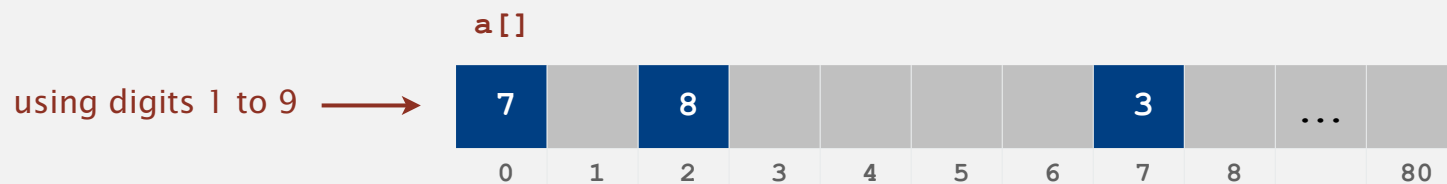

Sudoku: backtracking solution

Iterate through elements of search space.

- For each empty cell, there are 9 possible choices.
- Make one choice and recur.
- If you find a conflict in row, column, or box, then backtrack.

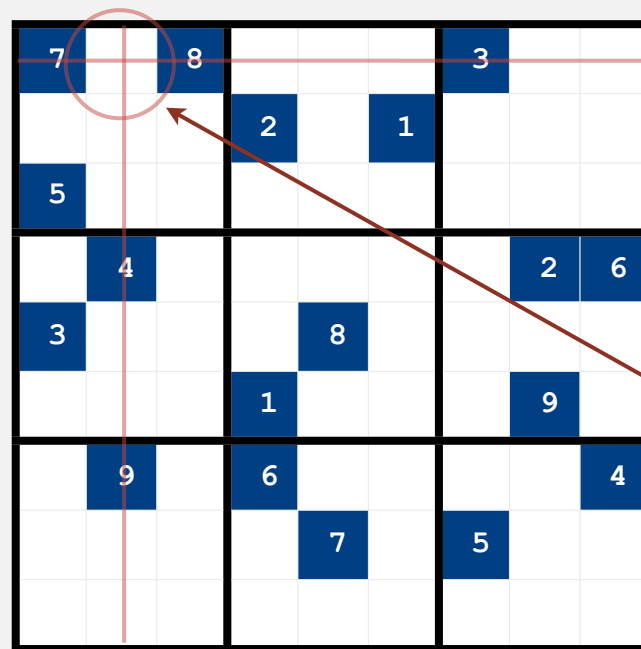

backtrack on 3, 4, 5, 7, 8, 9

Sudoku: Java implementation

```
private void enumerate(int k)
{
    if (k == 81)
    { process(); return; }

    if (a[k] != 0)
    { enumerate(k+1); return; }

    for (int r = 1; r <= 9; r++)
    {
        a[k] = r;
        if (!canBacktrack(k))
            enumerate(k+1);
    }

    a[k] = 0;
}
```

← found a solution

← cell k initially filled in;
recur on next cell

← try 9 possible digits
for cell k

← unless it violates a
Sudoku constraint
(see booksite for code)

← clean up

```
% more board.txt
7 0 8 0 0 0 3 0 0
0 0 0 2 0 1 0 0 0
5 0 0 0 0 0 0 0 0
0 4 0 0 0 0 0 2 6
3 0 0 0 8 0 0 0 0
0 0 0 1 0 0 0 9 0
0 9 0 6 0 0 0 0 4
0 0 0 0 7 0 5 0 0
0 0 0 0 0 0 0 0 0
```

```
% java Sudoku < board.txt
7 2 8 9 4 6 3 1 5
9 3 4 2 5 1 6 7 8
5 1 6 7 3 8 2 4 9
1 4 7 5 9 3 8 2 6
3 6 9 4 8 2 1 5 7
8 5 2 1 6 7 4 9 3
2 9 3 6 1 5 7 8 4
4 8 1 3 7 9 5 6 2
6 7 5 8 2 4 9 3 1
```

Sudoku is intractable

Remark. Natural generalization of Sudoku is NP-complete.

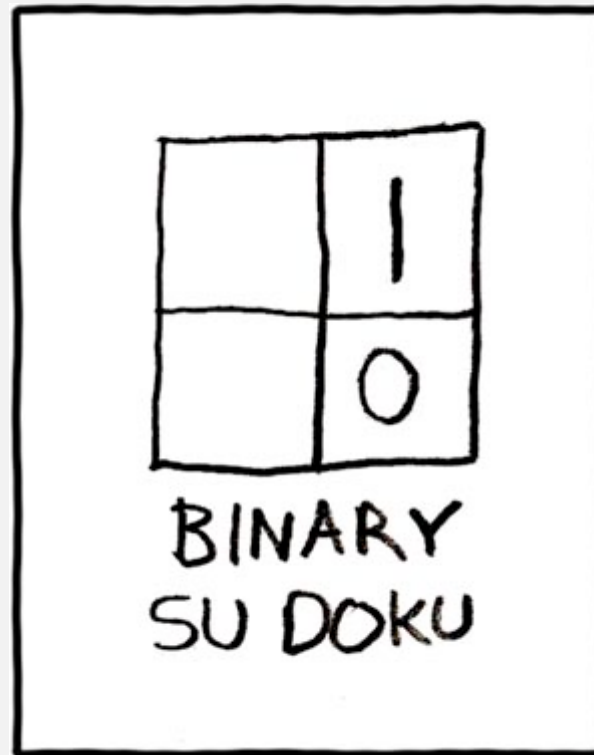

<http://xkcd.com/74>

- ▶ permutations
- ▶ backtracking
- ▶ counting
- ▶ **subsets**
- ▶ paths in a graph

Enumerating subsets: natural binary encoding

Given N elements, enumerate all 2^N subsets.

- Count in binary from 0 to $2^N - 1$.
- Maintain array $a[]$ where $a[i]$ represents element i .
- If 1, $a[i]$ in subset; if 0, $a[i]$ not in subset.

i	binary	subset	complement
0	0 0 0 0	empty	4 3 2 1
1	0 0 0 1	1	4 3 2
2	0 0 1 0	2	4 3 1
3	0 0 1 1	2 1	4 3
4	0 1 0 0	3	4 2 1
5	0 1 0 1	3 1	4 2
6	0 1 1 0	3 2	4 1
7	0 1 1 1	3 2 1	4
8	1 0 0 0	4	3 2 1
9	1 0 0 1	4 1	3 2
10	1 0 1 0	4 2	3 1
11	1 0 1 1	4 2 1	3
12	1 1 0 0	4 3	2 1
13	1 1 0 1	4 3 1	2
14	1 1 1 0	4 3 2	1
15	1 1 1 1	4 3 2 1	empty

Enumerating subsets: natural binary encoding

Given N elements, enumerate all 2^N subsets.

- Count in binary from 0 to $2^N - 1$.
- Maintain array $a[]$ where $a[i]$ represents element i .
- If 1, $a[i]$ in subset; if 0, $a[i]$ not in subset.

Binary counter from warmup does the job.

```
private void enumerate(int k)
{
    if (k == N)
        { process(); return; }
    enumerate(k+1);
    a[k] = 1;
    enumerate(k+1);
    a[k] = 0;
}
```

Digression: Samuel Beckett play

Quad. Starting with empty stage, 4 characters enter and exit one at a time, such that each subset of actors appears exactly once.

<i>code</i>	<i>subset</i>	<i>move</i>
0 0 0 0	<i>empty</i>	
0 0 0 1	1	enter 1
0 0 1 1	2 1	enter 2
0 0 1 0	2	exit 1
0 1 1 0	3 2	enter 3
0 1 1 1	3 2 1	enter 1
0 1 0 1	3 1	exit 2
0 1 0 0	3	exit 1
1 1 0 0	4 3	enter 4
1 1 0 1	4 3 1	enter 1
1 1 1 1	4 3 2 1	enter 2
1 1 1 0	4 3 2	exit 1
1 0 1 0	4 2	exit 3
1 0 1 1	4 2 1	enter 1
1 0 0 1	4 1	exit 2
1 0 0 0	4	exit 1

↑
ruler function

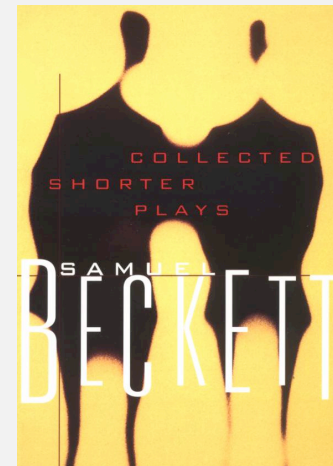

Digression: Samuel Beckett play

Quad. Starting with empty stage, 4 characters enter and exit one at a time, such that each subset of actors appears exactly once.

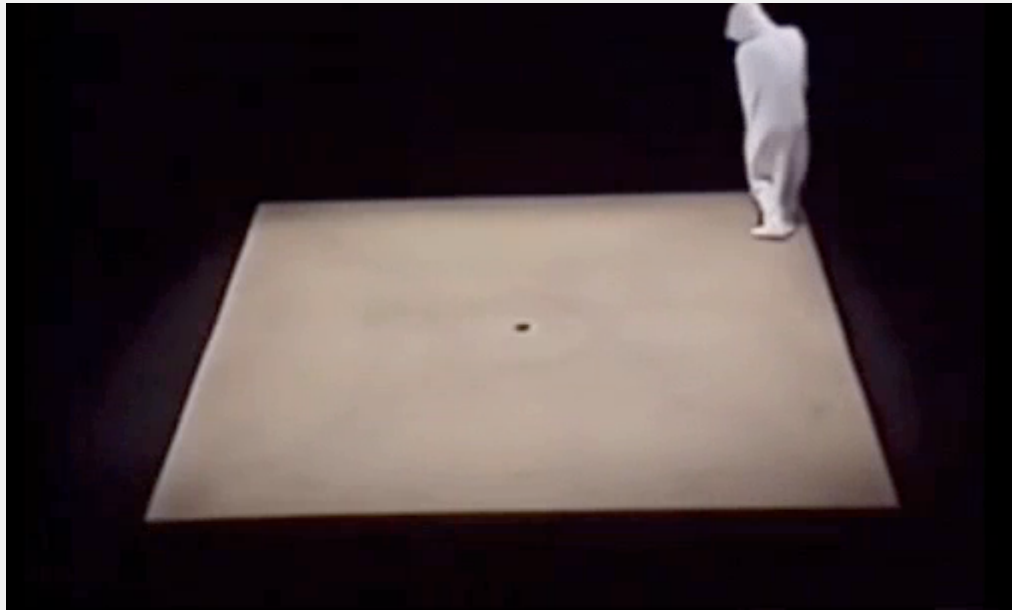

“ faceless, emotionless one of the far future, a world where people are born, go through prescribed movements, fear non-being even though their lives are meaningless, and then they disappear or die.” — Sidney Homan

Binary reflected gray code

Def. The k -bit **binary reflected Gray code** is:

- The $(k - 1)$ bit code with a 0 prepended to each word, followed by
- The $(k - 1)$ bit code in reverse order, with a 1 prepended to each word.

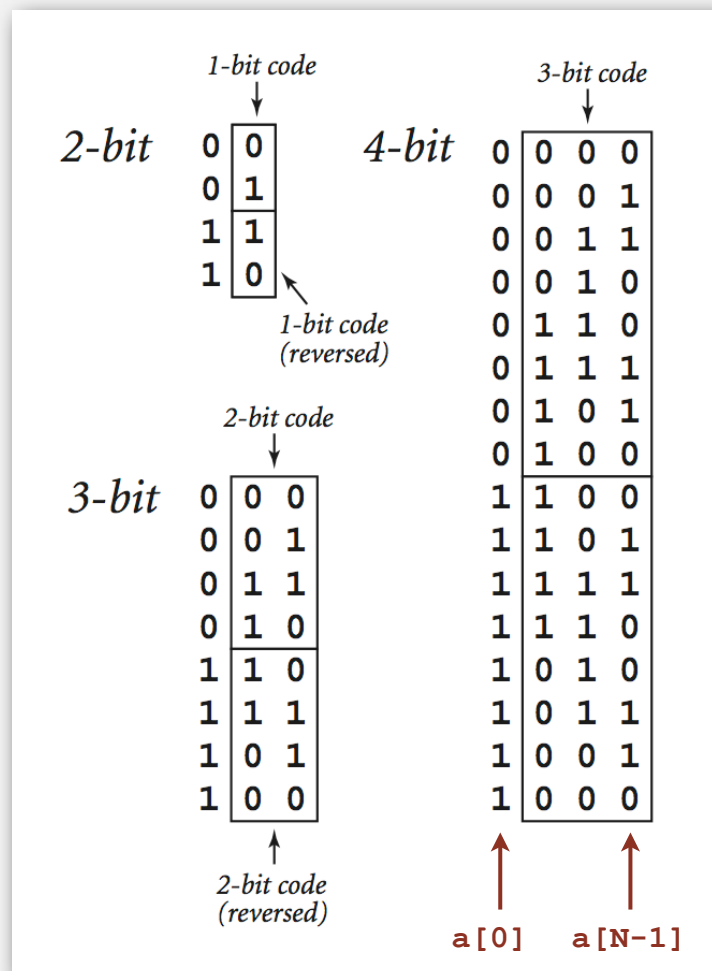

Enumerating subsets using Gray code

Two simple changes to binary counter from warmup:

- Flip $a[k]$ instead of setting it to 1.
- Eliminate cleanup.

Gray code binary counter

```
// all bit strings in a[k] to a[N-1]
private void enumerate(int k)
{
    if (k == N)
    { process(); return; }
    enumerate(k+1);
    a[k] = 1 - a[k];
    enumerate(k+1);
}
```

0	0	0
0	0	1
0	1	1
0	1	0
1	1	0
1	1	1
1	0	1
1	0	0

same values
since no cleanup

standard binary counter (from warmup)

```
// all bit strings in a[k] to a[N-1]
private void enumerate(int k)
{
    if (k == N)
    { process(); return; }
    enumerate(k+1);
    a[k] = 1;
    enumerate(k+1);
    a[k] = 0;
}
```

0	0	0
0	0	1
0	1	0
0	1	1
1	0	0
1	0	1
1	1	0
1	1	1

$a[0]$ $a[N-1]$

Advantage. Only one element in subset changes at a time.

More applications of Gray codes

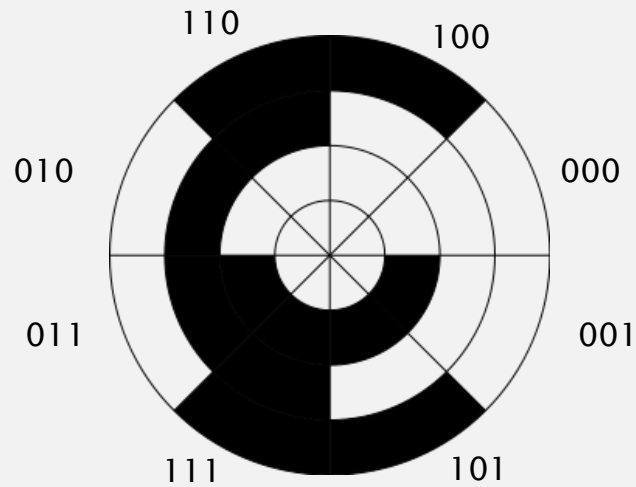

3-bit rotary encoder

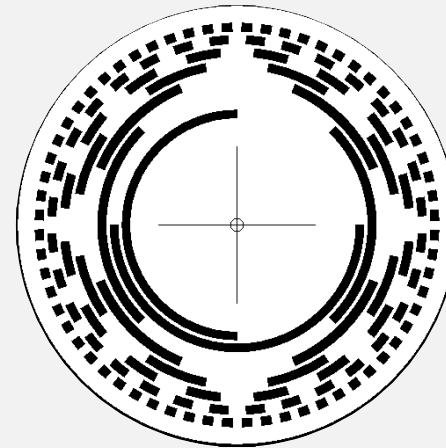

8-bit rotary encoder

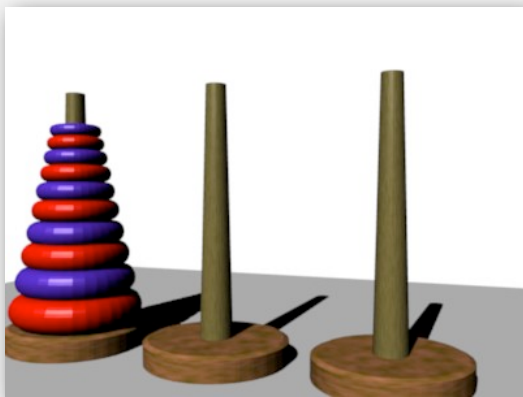

Towers of Hanoi

(move i th smallest disk when bit i changes in Gray code)

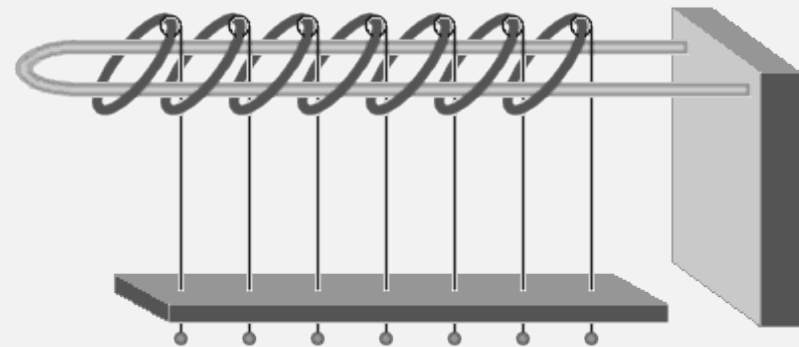

Chinese ring puzzle (Baguenaudier)

(move i th ring from right when bit i changes in Gray code)

Scheduling

Scheduling (set partitioning). Given N jobs of varying length, divide among two machines to minimize the makespan (time the last job finishes).

or, equivalently, difference
between finish times

job	length
0	1.41
1	1.73
2	2.00
3	2.23

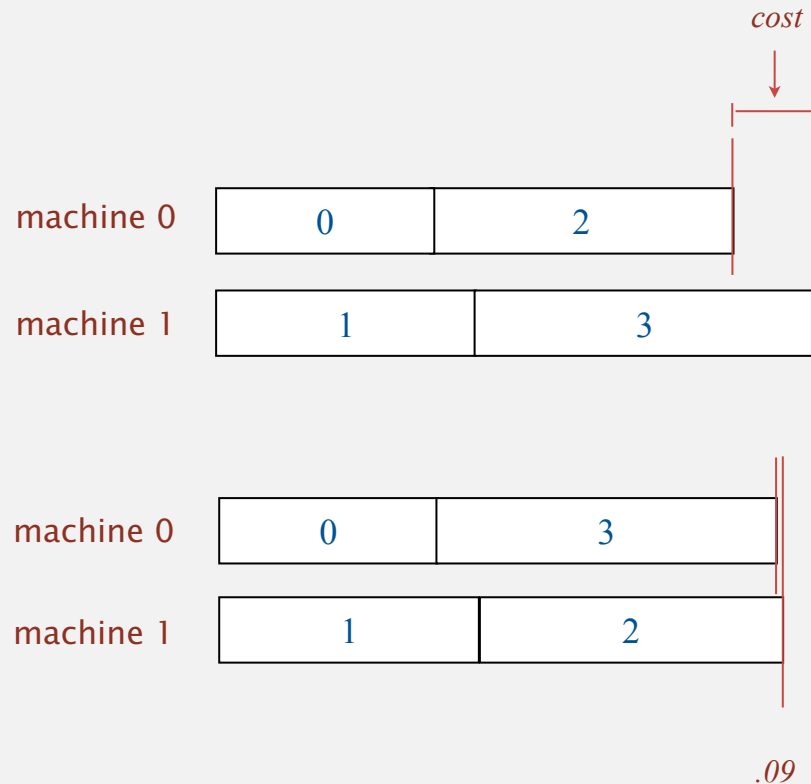

Remark. This scheduling problem is NP-complete.

Scheduling: improvements

Brute force. Enumerate 2^N subsets; compute makespan of each; return best.

Many opportunities to improve.

- Fix first job to be on machine 0. ← factor of 2 speedup
- Maintain difference in finish times. ← factor of N speedup (using Gray code order)
(and avoid recomputing cost from scratch)
- Backtrack when partial schedule cannot beat best known. ← huge opportunities for improvement on typical inputs
- Preprocess all 2^k subsets of last k jobs; cache results in memory. ← reduces time to 2^{N-k} at cost of 2^k memory

```
private void enumerate(int k)
{
    if (k == N) { process(); return; }
    if (canBacktrack(k)) return;
    enumerate(k+1);
    a[k] = 1 - a[k];
    enumerate(k+1);
}
```

- ▶ permutations
- ▶ backtracking
- ▶ counting
- ▶ subsets
- ▶ **paths in a graph**

Enumerating all paths on a grid

Goal. Enumerate all simple paths on a grid of adjacent sites.

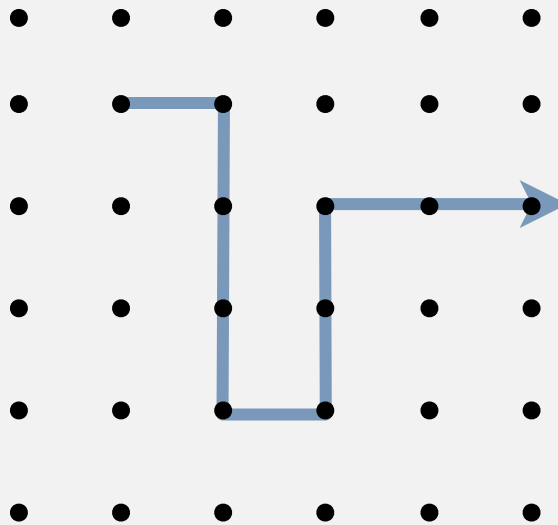

no two atoms can occupy
same position at same time

Application. Self-avoiding lattice walk to model polymer chains.

Enumerating all paths on a grid: Boggle

Boggle. Find all words that can be formed by tracing a simple path of adjacent cubes (left, right, up, down, diagonal).

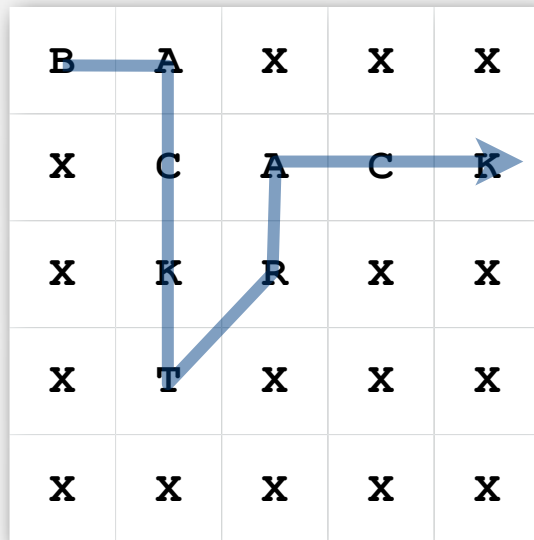

Backtracking. Stop as soon as no word in dictionary contains string of letters on current path as a prefix \Rightarrow use a trie.

B
BA
BAX

Boggle: Java implementation

```
private void dfs(String prefix, int i, int j)
{
    if ((i < 0 || i >= N) ||
        (j < 0 || j >= N) ||
        (visited[i][j]) ||
        !dictionary.containsAsPrefix(prefix))
        return;

    visited[i][j] = true;
    prefix = prefix + board[i][j];

    if (dictionary.contains(prefix))
        found.add(prefix);

    for (int ii = -1; ii <= 1; ii++)
        for (int jj = -1; jj <= 1; jj++)
            dfs(prefix, i + ii, j + jj);

    visited[i][j] = false;
}
```

string of letters on current path to (i, j)

backtrack

add current character

add to set of found words

try all possibilities

clean up

Hamilton path

Goal. Find a simple path that visits every vertex exactly once.

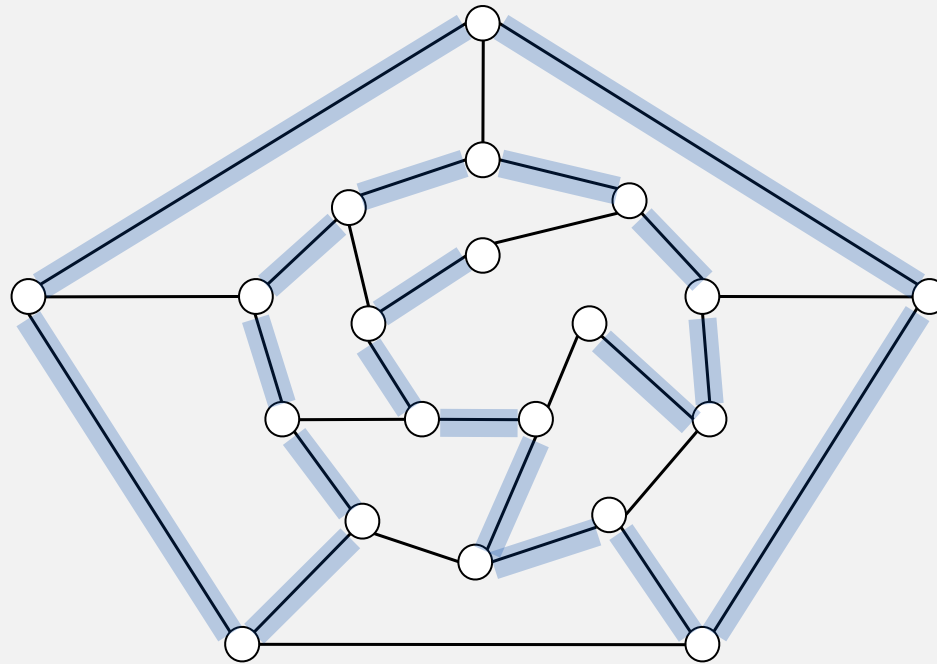

visit every edge exactly once



Remark. Euler path easy, but Hamilton path is NP-complete.

Knight's tour

Goal. Find a sequence of moves for a knight so that (starting from any desired square) it visits every square on a chessboard exactly once.

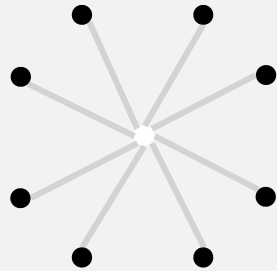

legal knight moves

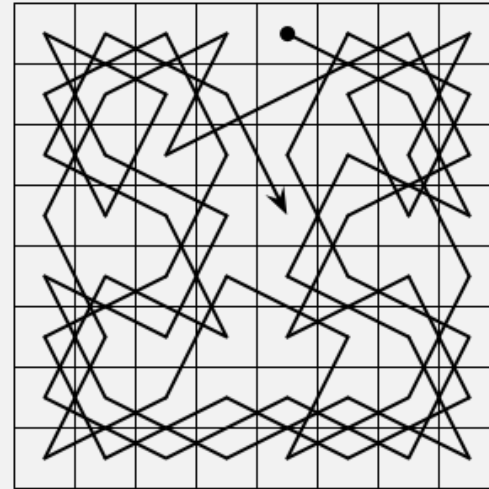

a knight's tour

Solution. Find a Hamilton path in knight's graph.

Hamilton path: backtracking solution

Backtracking solution. To find Hamilton path starting at v :

- Add v to current path.
- For each vertex w adjacent to v
 - find a simple path starting at w using all remaining vertices
- Clean up: remove v from current path.

Q. How to implement?

A. Add cleanup to DFS (!!)

Hamilton path: Java implementation

```
public class HamiltonPath
{
    private boolean[] marked;    // vertices on current path
    private int count = 0;      // number of Hamiltonian paths
```

```
    public HamiltonPath(Graph G)
    {
        marked = new boolean[G.V()];
        for (int v = 0; v < G.V(); v++)
            dfs(G, v, 1);
    }
```

```
    private void dfs(Graph G, int v, int depth)
    {
```

```
        marked[v] = true;
        if (depth == G.V()) count++;
```

found one →

↖ length of current path
(depth of recursion)

```
        for (int w : G.adj(v))
            if (!marked[w]) dfs(G, w, depth+1);
```

← backtrack if w is
already part of path

```
        marked[v] = false; ← clean up
```

```
    }
```

```
}
```

Exhaustive search: summary

problem	enumeration	backtracking
N-rooks	permutations	no
N-queens	permutations	yes
Sudoku	base-9 numbers	yes
scheduling	subsets	yes
Boggle	paths in a grid	yes
Hamilton path	paths in a graph	yes